

MAI Reduction in Asynchronous MC-CDMA (4G) System using Multiuser Detection with Different Cross-Correlation Matrices

Anmol Kumar¹ and Jyoti Saxena²

¹*Research Scholar, Punjab Technical University, Kapurthala, India-144601*

E-mail: goyalruby@gmail.com, Phone: +91-9855122285

²*Professor, Department of Electronics & Communication Engg.,*

GZS PTU Campus, Bathinda, India-151001

E-mail: jyotianupam@yahoo.com

Abstract

Multiple access interference (MAI) occurs in a CDMA (code division multiple access) based systems due to non orthogonality of spreading codes. Cross-correlation between different user's waveform must be zero ideally, but because of non orthogonality of codes, cross-correlation between different users will have some non zero values due to which MAI occurs. MC-CDMA (multi carrier code division multiple access) is being considered as basic radio technology for fourth generation (4G) and also for fifth generation (5G) of cellular mobile systems. A heavily loaded MC-CDMA system is more prone to MAI due to multipath fading. Peak-to-average-power ratio (PAPR) is another problem which affects the MC-CDMA system. In PAPR effect different subcarriers of MC-CDMA system are received with variation in their powers. PAPR increases the inter subcarrier interference (ICI) which in turn increases MAI. Presence of MAI increases the bit error rate (BER) of MC-CDMA signals. Multiuser detection has been an efficient technique to mitigate MAI in CDMA based systems. In this paper optimum multiuser detector is tested for different orthogonal codes with different cross-correlation properties and their effect on MAI is observed. Simulation results show that orthogonal code with low cross-correlation values significantly reduces the MAI and PAPR effect in MC-CDMA systems.

Index Terms: MC-CDMA, MAI, Multiuser Detection (MUD), PAPR.

1. INTRODUCTION

A lot of research for CDMA based system has been done and different technique and algorithms have been proposed to reduce MAI [1-9], but amount of research on MC-

CDMA systems has not been done on a large scale.

MAI is a factor that limits the efficiency of a MC-CDMA system [9-11]. MAI in a MC-CDMA system occurs because of cross correlation between different bits of different users. In a synchronous environment, cross correlation between bits of different users is assumed to be zero when all the user's signals are perfectly orthogonal, but in a wireless environment orthogonality of different user's waveforms cannot be maintained so MAI occurs and in an asynchronous environment occurrence of MAI is inherent owing to different timing offsets between users. Frequency selective fading, non-linear power amplification and PAPR effect are some other factors which contribute to MAI. PAPR increases in a MC-CDMA system because subcarriers are densely packed which results in amplitude variation of subcarriers[12]. Consequently, with the change in amplitudes of different subcarriers their power levels also vary, which in turn increases inter subcarrier interference (ISI) and as a result MAI increases.

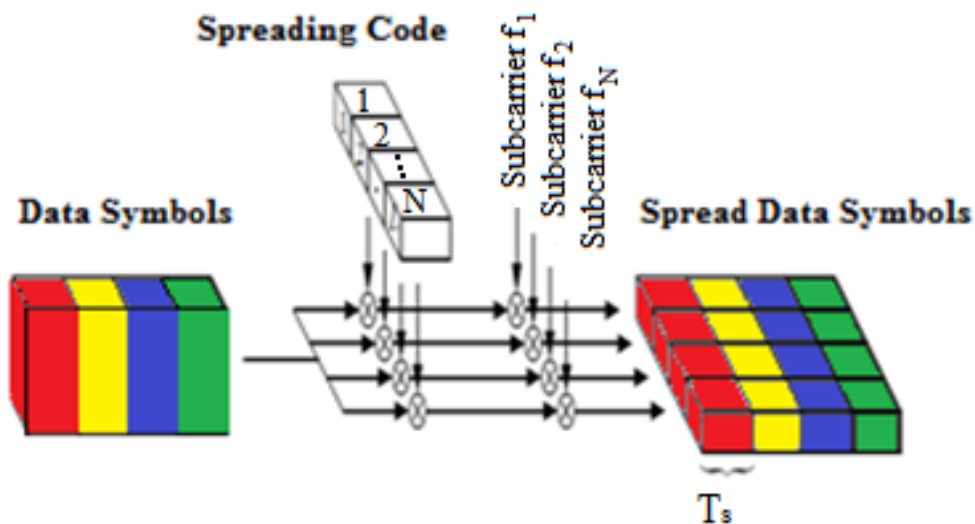

Figure 1: MC-CDMA Transmitter

MC-CDMA is a combination of OFDM and CDMA [10-13], in which different characteristics of both the techniques have been combined to give a new technique which can effectively use the available spectrum to achieve high frequency diversity and at the same time it maintains high data rates which is a primary feature of 4G technology [14-16]. MC-CDMA is being investigated as the basic radio technology to provide 4G mobile services. In MC-CDMA multiple chips for a data symbol are not sequential but transmitted in parallel over different subcarriers as shown in Fig. 1. It achieves high frequency diversity because it will rarely happen that all the subcarriers will be in deep fade simultaneously.

It is a tough task to analyze a MC-CDMA system in asynchronous (uplink) environment, because in uplink all the users transmit signal asynchronously i.e. at irregular time intervals and amount of MAI is large in case of asynchronous systems because cross-correlation between different users is high. So role of selecting an efficient orthogonal code with good cross-correlation property is of utmost importance. In this paper different orthogonal codes (spreading codes) with different cross-correlation properties have been applied. It can be observed from the simulation results that effect of MAI can be mitigated by applying orthogonal code having smaller cross-correlation values.

This paper has been divided into 6 section. In section 2, formation of cross-correlation matrix for asynchronous detection has been explained. In section 3, multiuser detection has been discussed. Section 4 is for Optimum MUD based receiver model. Simulation results have been discussed in section 5. Conclusion of this paper is briefed in section 6.

2. ASYNCHRONOUS DETECTION

Fig. 2 shows a conventional detector where matched filters are used to detect bits from a composite signal.

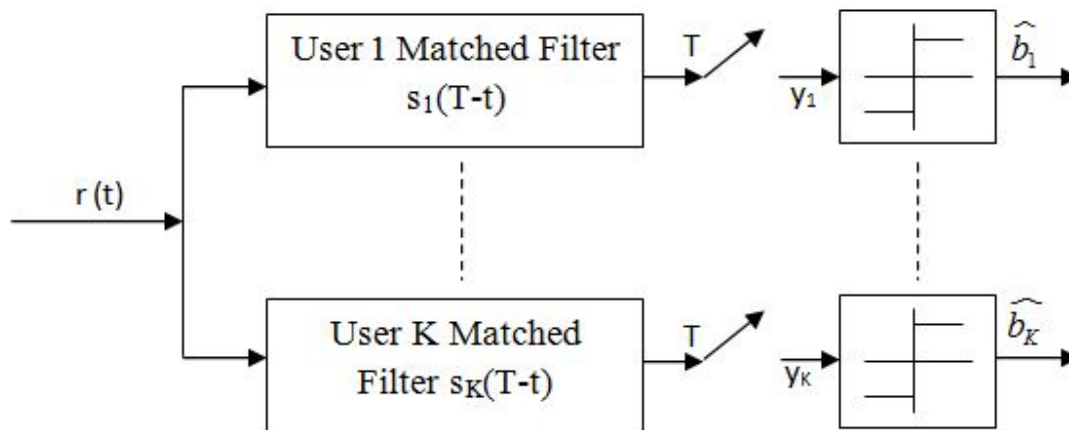

Figure 2: Matched filter detection

Received signal $r(t)$ is given as:

$$r(t) = \sum_{k=1}^K b_k A_k S_k(t) + n(t), t \in [0, T] \quad (1)$$

Where

$b_k \in [-1, +1]$, is the bits transmitted by k^{th} user

A_k is the amplitude of k^{th} user

S_k is the k^{th} user's spreading code

$n(t)$ is additive white Gaussian noise (AWGN) and K is the number of users.

Here for asynchronous case we assume two user systems with a matched filter receiver (conventional detector).

The received composite signal for two users can be written as $r(t) = b_1 A_1 S_1(t) + b_2 A_2 S_2(t) + n(t)$

Matched filter outputs y_1 and y_2 can be given as:

$$y_1 = \int_0^T s_1(t)r(t)dt$$

$$y_2 = \int_0^T s_2(t)r(t)dt$$

In matrix form received signal y_1 and y_2 can be given as:

$$\begin{bmatrix} y_1 \\ y_2 \end{bmatrix} = \begin{bmatrix} 1 & \rho_{12} \\ \rho_{21} & 1 \end{bmatrix} \begin{bmatrix} A_1 & 0 \\ 0 & A_2 \end{bmatrix} \begin{bmatrix} b_1 \\ b_2 \end{bmatrix} + \begin{bmatrix} n_1 \\ n_2 \end{bmatrix}$$

we represent

$$y = [y_1, y_2]^T, \quad b = [b_1, b_2]^T \quad \text{and}$$

$$R = \begin{bmatrix} 1 & \rho_{12} \\ \rho_{21} & 1 \end{bmatrix}, \quad A = \begin{bmatrix} A_1 & 0 \\ 0 & A_2 \end{bmatrix}$$

$$n = [n_1, n_2]^T$$

Where ρ_{12} and ρ_{21} represents cross-correlation between the spreading sequences of bits b_1 and b_2 .

Now it can be summed up in following equation

$$y = RA b + n \tag{2}$$

We know that in synchronous detection decision can be made bit by bit but in asynchronous detection bits overlap and detection is based on taking all the bits into account, so for asynchronous case:

$$r(t) = \sum_{k=1}^K A_k(t) S_k(t) b_k(t - \tau_k) + n(t) \tag{3}$$

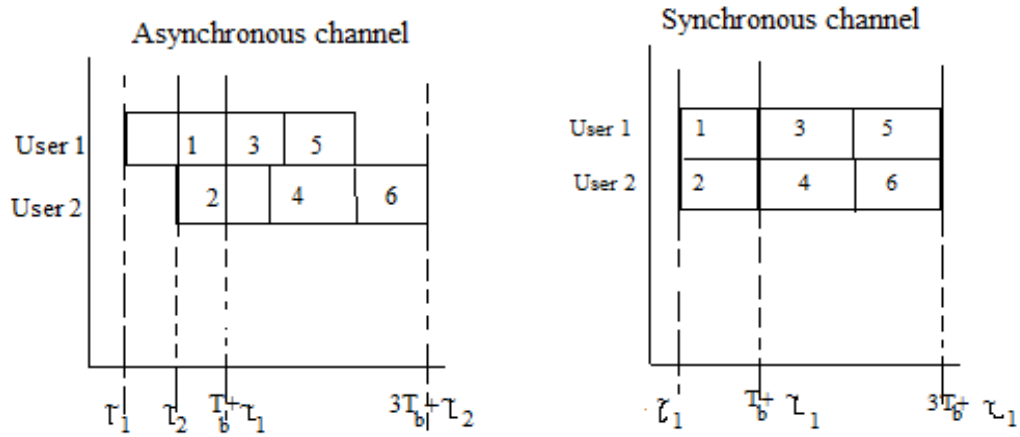

Figure 3: Synchronous & Asynchronous channel

The matrix R now contains partial correlations that exist between every pairs of K users and their N bits. As shown in Fig. 3, bits 1, 3 and 5 belongs to user 1 and bits 2, 4 and 6 belongs to user 2. This correlation matrix extends to 6×6 dimension. As shown in Fig. 4 most of the elements of this matrix are zero as most of the bits do not overlap and for the bits which overlap different values of correlation coefficients are given below

$$R = \begin{bmatrix} 1 & \rho_{2,1} & 0 & 0 & 0 & 0 \\ \rho_{1,2} & 1 & \rho_{3,2} & 0 & 0 & 0 \\ 0 & \rho_{2,3} & 1 & \rho_{4,3} & 0 & 0 \\ 0 & 0 & \rho_{3,4} & 1 & \rho_{5,4} & 0 \\ 0 & 0 & 0 & \rho_{4,5} & 1 & \rho_{6,5} \\ 0 & 0 & 0 & 0 & \rho_{5,6} & 1 \end{bmatrix}$$

Figure 4: Cross-correlation Matrix

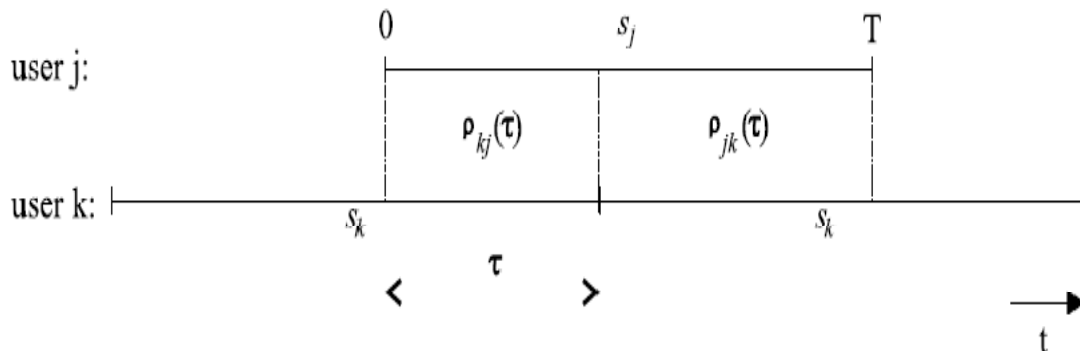

Figure 5: Symbol time overlapping in asynchronous MC-CDMA

For asynchronous MC-CDMA two cross correlation between every pair of spreading sequences (orthogonal codes) have to be defined that depends upon offset between the signals. This can be seen in Fig. 5 above. This figure shows that one symbol time for user j overlaps with two user times of user k. When the offset τ_j of user j is smaller than the offset τ_k of user k then two cross correlations can be defined as;

$$\rho_{jk}(\tau) = \int_{\tau}^T s_j(t) s_k(t - \tau) dt \quad (3)$$

$$\rho_{kj}(\tau) = \int_0^T s_j(t) s_k(t + T - \tau) dt \quad (4)$$

Where $\tau \in [0, T]$

so at any observation interval (bit period), the previous bit $b(i-1)$, current bit of interest $b(i)$ and next bit $b(i+1)$ may overlap with each other in an asynchronous environment.

3. MULTIUSER DETECTION

In a conventional method (matched filter detection) of detecting in a CDMA based system as shown in Fig. 2, MAI is not taken into account. This method is termed as single user detection where each user is detected separately and interference caused by other user is treated as noise but in multiuser detection interference from other user is used in detection of each individual user MUD[2-5] is basically a detection strategy which has been extensively researched in CDMA based systems and it has been proved to be a good technique to mitigate MAI and near far problem. Fig. 6 shows a multiuser detector where a number of matched filters are employed to detect corresponding bits and further these bits are processed by Multiuser detection algorithm which is based on maximum likelihood detection where a particular bit combination of all the users gives closest match of the estimated and received value.

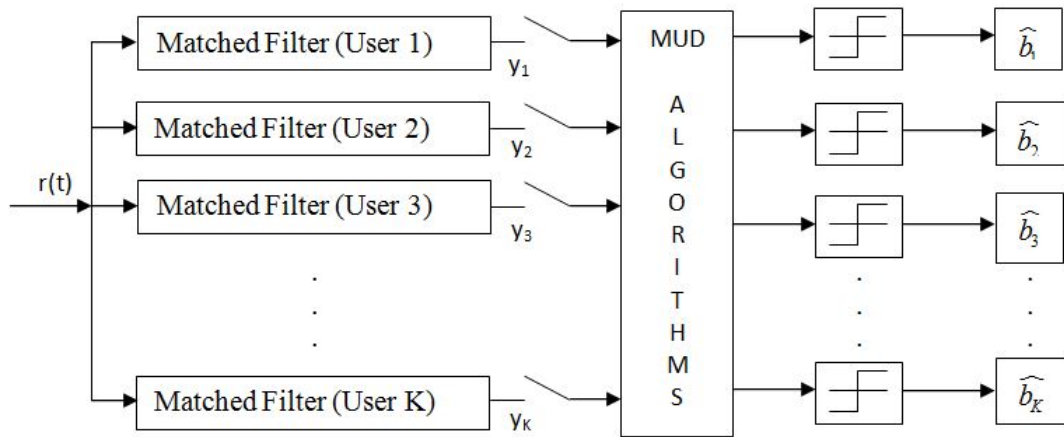

Figure 6: Multiuser Detection

A multiuser detector utilizes the information available in MAI term to detect the signal and not treat it as a noise. A multiuser detector has to do 2^K comparisons for K number of users to give the best combinations of detected bit of all users. The optimum estimate of \hat{b} will minimize the probability of error. So optimum multiuser detector jointly maximizes the likelihood functions for K user's bits $\{b_1, b_2, \dots, b_K\}$ that maximize the objective function as given by equation (5) below.

$$\hat{b} = \arg_{b \in \{-1,1\}} \max (2b^T y - b^T A R A b) \tag{5}$$

4. SYSTEM MODEL

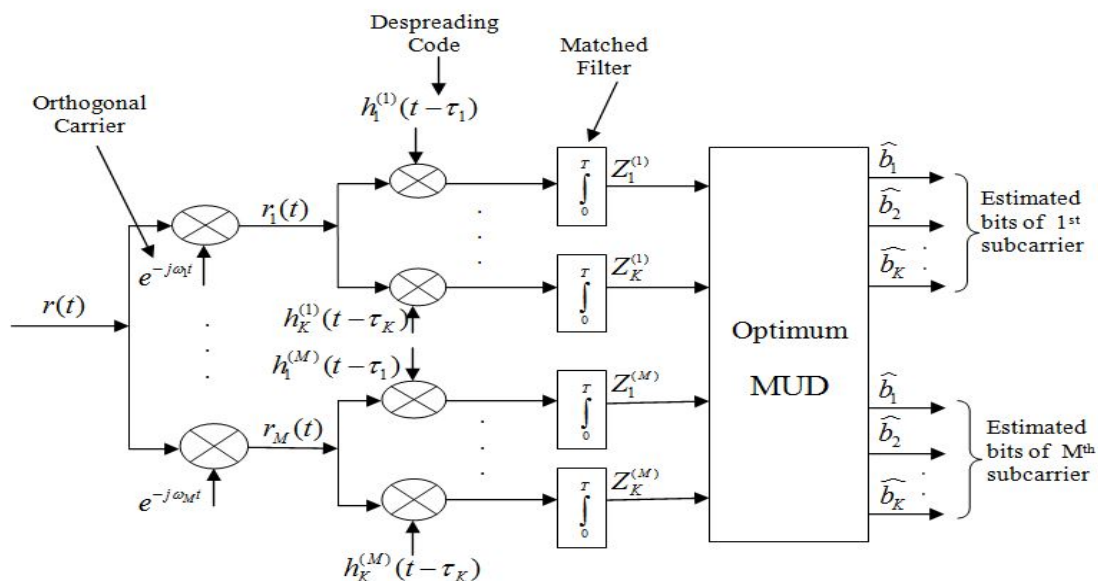

Figure 7: Optimum MUD for MC-CDMA

In the Fig. 7 above, composite signal received has been divided among M number of subcarriers. Subcarrier f_1 carries a small part of data of all the users and this data is spread by spreading code h_1 i.e. 1st chip. So in this way entire signal (from subcarrier f_1 to f_M) is coded by different spread sequences from S_1 to S_K and received signal on m^{th} subcarrier can be given as:

$$r_m(t) = \sum_{k=1}^K [A_k S_{k,m}(t) b_k(t)] + n(t) \quad (6)$$

Where,

A_k is the amplitude of k^{th} user ($k = 1, \dots, K$)

M is the total number of sub-carriers,

$b_k(t)$: k^{th} user's transmitted bit

$S_{k,m}(t)$: k^{th} user's spreading sequence for the m^{th} sub-carrier,

$S_k(t) = \{S_{k,0}(t), S_{k,1}(t), \dots, S_{k,M}(t)\}$: k^{th} user's spreading code over all sub-carriers, $\omega_m = 2\pi f_m$, where f_m ($m=1, \dots, M$) are the subcarrier frequencies .

Now the output of the matched filter for m^{th} subcarrier as shown in Fig. 7 can be represented in matrix form as

$$z_m = RAb + n \quad (7)$$

Where R is the cross-correlation matrix and A is amplitude matrix

$$A = \text{diag} [A_1 \quad \dots \quad A_K]$$

b is bit matrix, $b = [b_1, b_2, \dots, b_K]^T$ and n is the noise matrix $n = [n_1, n_2, \dots, n_K]^T$

Equation (7) can further be written as

$$\hat{b} = \arg_{b \in \{-1,1\}} \max (2b^T Z_m - b^T A R A b) \quad (8)$$

Equation (8) detects the data bit \hat{b} by maximizing this objective function. So for K number of users data Bit vector $b = [b_1, b_2, \dots, b_K]^T$ is selected which maximize this objective function.

5. SIMULATION AND DISCUSSION

To examine the variation of MAI (BER) with different values of cross correlation in the cross-correlation matrix, we generate three types of orthogonal codes i.e. gold code, kasami code and walsh code of length 31 each. It is assumed that subcarriers are perfectly synchronized. There is no frequency offset and non-linear distortion. The

channel is taken to be slowly fading with Rayleigh distribution. Received signal is assumed to be corrupted by AWGN. Number of subcarriers used is taken equal to 31 and QPSK modulation is used. Number of users is taken as 4. A total of 10000 bits for each user are transmitted and received.

Optimum (maximum-likelihood) multiuser detector has been used to detect the user's bits. Bits of all the users are spread, first using walsh codes then using kasami code and in the last using gold code. Cross-correlation matrices are examined for all the three orthogonal codes. In the first case users are received at the detector end with equal powers and in the second case with unequal power levels (PAPR effect). Table 1, Table 2 and Table 3 show the cross-correlation matrices for walsh code, kasami code and gold code respectively for equal power level scenario. Earlier in Fig. 4, a cross-correlation matrix is shown with two users where each user transmits only three bits in an asynchronous environment. So it is a 6×6 matrix with most of the elements of this matrix has zero value because only 3 bits for each user has been transmitted. But in this case we have taken 4 users and for each user 10000 bits have been transmitted and received. So in this case we get a 4×4 matrix where each element give mean value of cross correlation for all the 10000 bits received for each user. Similarly diagonal elements represent mean values for autocorrelation (amplitude) for each user. Negative values of non-diagonal cross-correlation elements in Table 1, Table 2 and Table 3, actually represents zero cross-correlation as we are taking anti-podal spreading codes. So more the number of negative non-diagonal elements lesser is the cross-correlation and better is the BER performance of orthogonal code as can be seen in Fig. 8. Moreover larger the value of positive non-diagonal elements larger is the cross-correlation and larger is the BER.

It is clear that BER performance of walsh code (as a spreading code) is best among all the three codes. Worst performance is given by gold code.

Table1: Cross-correlation matrix for walsh code

31	-1	-1	-1
-1	31	-1	7
-1	-1	31	-1
-1	7	-1	31

Table2: Cross-correlation matrix for kasami code

31	1	-1	-1
1	31	1	1
-1	1	31	-1
-1	1	-1	31

Table3: Cross-correlation matrix for gold code

31	7	-7	-7
7	31	1	1
-7	1	31	-9
-7	1	-9	31

Similar to the first case, BER performance under PAPR is also examined. In this case peak- to-average power ratio (PAPR) is taken as equal to 4. Table 4, Table 5 and Table 6 give the cross-correlation elements for walsh, kasami and gold code respectively. Here also walsh code gives the best performance followed by kasami and worst performance is by gold code. It can be seen that total number of negative non-diagonal elements are 10 in Table 4 where as in Table 5 and Table 6, total number of negative non-diagonal elements are 6. This is the reason for the good BER performance by walsh code as shown in Fig. 9. It can be seen from Fig. 9 that kasami code gives slightly better performance than gold code because values of positive non-diagonal elements are larger in Table 6 than in Table 5, though both Table 5 and Table 6 have equal number of negative non-diagonal elements. It can also be observed that diagonal elements in Table 4, Table 5 and Table 6 have higher values when compared with their counterparts in Table 1, Table 2 and Table 3. This is also because of PAPR effect which varies the power level (amplitude level) of different subcarriers.

Table4: Cross-correlation matrix for walsh code with PAPR effect

31.0	-3.1622	-2.2360	-1.0
-3.1622	310.0000	-7.0710	22.1359
-2.2360	-7.0710	155.0000	-2.2360
-1.0	22.1359	-2.2360	31.0

Table5: Cross-correlation matrix for kasami code with PAPR effect

31	3.1623	-2.2361	-1
3.1623	310.0000	7.0711	3.1623
-2.2361	7.0711	155.0000	-2.2361
-1	3.1623	-2.2361	31

Table6: Cross-correlation matrix for gold code with PAPR effect

31	22.1359	-15.6525	-7
22.1359	310.0000	7.0711	3.1623
-15.6525	7.0711	155.0000	-20.1246
-7	3.1623	-20.1246	31

Fig. 8 gives the BER performance of all three codes under equal power scenario. It can be seen that performance of walsh code is best among all the three codes. So optimum multiuser detector is robust to MAI when walsh code is used as spreading code. In case of PAPR effect, subcarriers are detected with different power levels due to which subcarriers lost their orthogonality which in turn increases MAI. In Fig. 9 performance of all the three codes can be observed with PAPR effect. Walsh code based optimum multiuser detector gives excellent performance as compared to kasami and gold code based multiuser detector. We can see in Fig. 9 that in walsh code based multiuser detector, BER decreases more quickly with the increase in SNR whereas performance of kasami and gold code based detector is almost constant with the increase of SNR. So a walsh code based multiuser detector is capable of mitigating the effect of MAI as well as PAPR effectively. It can be analyzed from the above observation that walsh codes are perfectly orthogonal and give low cross-correlation values. Moreover under imperfect power scenario BER of walsh detector increases slightly in comparison with the scenario where users are received with equal powers. It indicates that walsh detector gives excellent resistant to PAPR effect as it maintains its orthogonality even under imperfect power scenario. Simulation has been conducted for only 4 users for the better understanding of the concept but it can be extended to more number of users also.

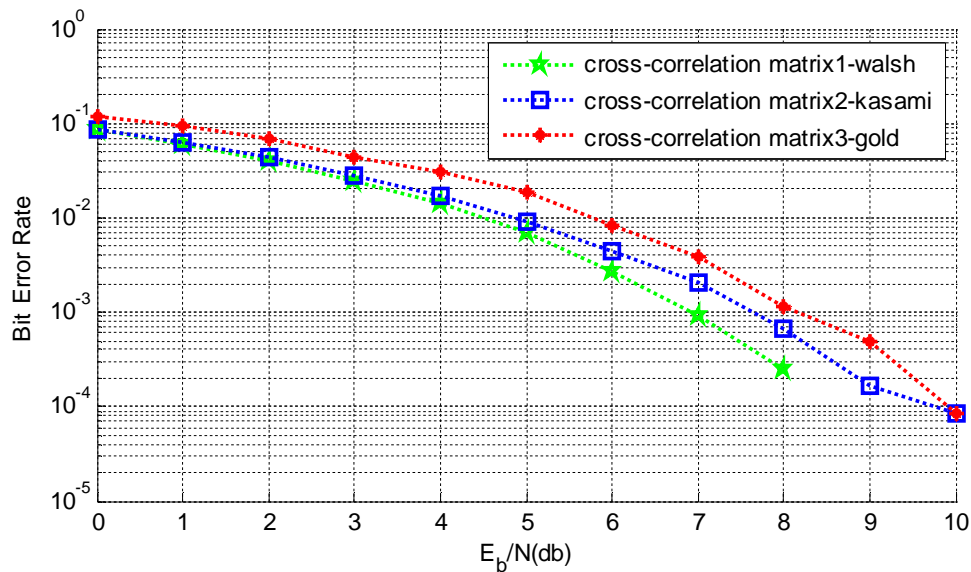

Figure 8: BER performance comparison under equal power control

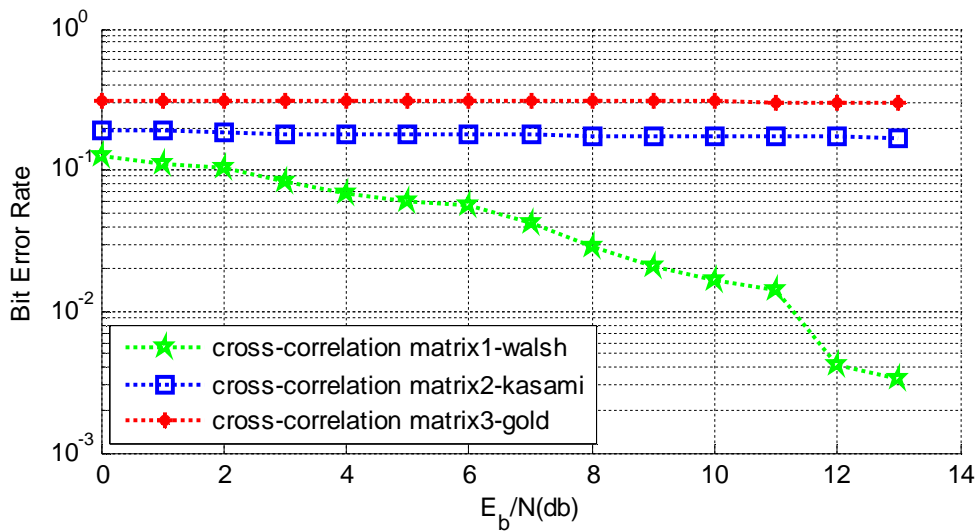

Figure 9: BER performance under unequal power scenario (PAPR effect)

6. CONCLUSION

We investigated the effect of cross-correlation matrices on the BER performance by taking three types of orthogonal codes. It is clear that cross-correlation matrices with elements having smaller numerical values gives better BER performance. BER performance depends upon the cross-correlation matrix which in turn depends upon the different location offsets between the different users. Since offset due to physical separation of users can not be avoided in an asynchronous environment, so orthogonal codes with better cross-correlation and auto-correlation properties have to be used for better BER performance. It has been proved that walsh code based MC-CDMA multiuser detector could be effectively used to detect MC-CDMA signals in the presence of MAI and PAPR. The findings of this paper can be used to design codes with low cross-correlation and high orthogonality. Performance of other multiuser detectors such as MMSE, decorrelator, successive interference cancellation (SIC) and parallel interference cancellation (PIC) can also be observed for these codes under various conditions.

REFERENCES

- [1] F. Adachi, D. Garg, S. Takoka & K. Takoka, "Broadband CDMA techniques," *wireless communications, IEEE*, 12, pp. 8-18.
- [2] S. Verdu, 1998, "*Multiuser detection*," *cambridge university press*, UK.
- [3] S. Verdu, 1986, "Minimum probability of error for asynchronous Gaussian multiple access channels," *IEEE Trans. on Inform.*, 32, pp. 85-96.

- [4] R. Lupas & S. Verdu, 1989, "Linear multiuser detector for synchronous code division Multiple access channels," *IEEE Transactions on Information theory*, 35, pp. 123-136.
- [5] M. K. Varanasi & B. Aazhang, 1991, "Near-optimum detection in synchronous code Division multiple access systems," *IEEE Trans. on Communications*, 39, pp. 725-736.
- [6] Y.Li & R. Steel R., 1994, "Serial interference cancellation method for CDMA," *IEEE Electronic Letters*, 30, pp. 1581-1583.
- [7] A. Duel-Hallen, 1995, "Decorrelating Decision-Feedback Multiuser Detector for Asynchronous CDMA Channels," *IEEE Trans. Commun.*, 43, pp. 421-434.
- [8] B. Varanasi & M.K.; Aazhang, 1990, "Multistage detection in asynchronous CDMA Communications," *IEEE Transactions on Communications*, 38, pp. 509-519.
- [9] D. Divsalar & M. Simon, 1996, "New approach to parallel interference cancellation for CDMA," *IEEE, Global Telecommunication Conference*, pp. 1452-1457.
- [10] E. A. Sourour & M. Nakagawa, 1996, "Performance of orthogonal multicarrier CDMA in a multipath fading channel," *IEEE Trans. on Communications*, 44, pp. 356-367.
- [11] S. Hara & R. Prasad, 1997, "Overview of multicarrier CDMA," *IEEE Communications Magazine*, 35, pp. 126-133.
- [12] Caldwell R. & Anpalagan A., 2005, "Meeting mobile's demands with multicarrier systems", *IEEE Potentials*, Vol. 24, issue 5, pp. 27-31.
- [13] X. Gui & T.S. Ng, 1999, "Performance of asynchronous orthogonal multicarrier CDMA system in frequency selective fading channel," *IEEE Transactions on communication*, 47, pp. 1084-1091.
- [14] N. Yee, J. Linmartz, & G. Fettweis, 1993, "Multicarrier CDMA in indoor wireless radio Networks," [online].
- [15] S. Hara & R. Prasad, 2013, "Multicarrier techniques for 4G mobile communication," (Boston, MA: Artech House).
- [16] L. Hanzo, L.-L. Yang, E.-L. Kuan, & K. Yen, 2003, "Single and Multi-Carrier CDMA: Multi-User Detection," *Space-Time Spreading, Synchronization, Standards and Networking*, Piscataway, NJ: IEEE Press/Wiley.

